

Registration Number: E3SMEW5

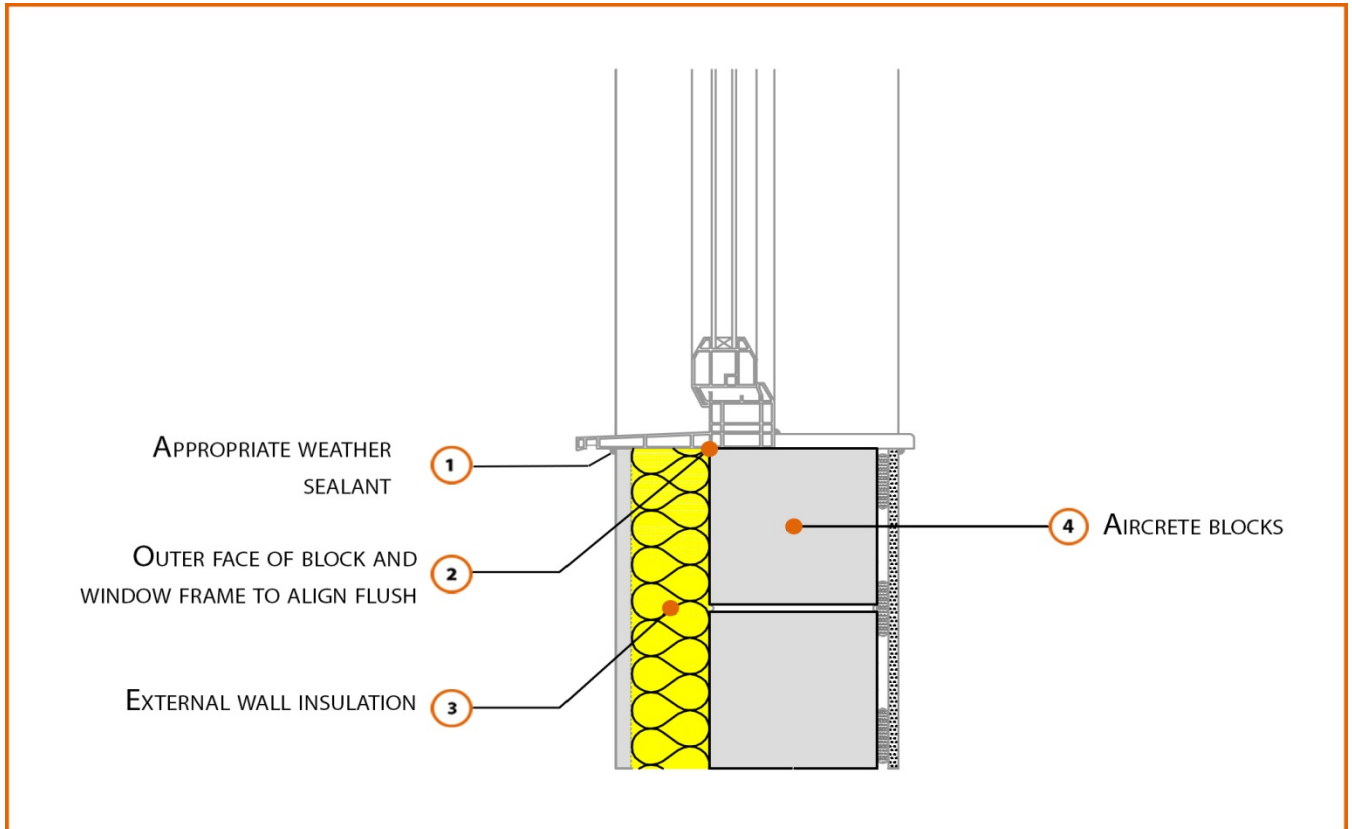

Build Up

Solid External Masonry Wall

215mm Aircrete Solid Wall ($\lambda \leq 0.19$ W/mK)

Render & Insulation ($\lambda = 0.022$ W/mK)

Calculated ψ -values

Cavity Insulation	Inner leaf blockwork
	Aircrete Block $\lambda \leq 0.19$ W/mK
	ψ -value W/mK
50mm $\lambda=0.022$	0.019
75mm $\lambda=0.022$	0.022
100mm $\lambda=0.022$	0.025

Points to Watch

- Wall insulation to be carried up to the underside of the cill member
- Ensure window and door throated cill drip extends beyond face of insulation
- Ensure block face is kept clean of mortar snots and other debris during construction to permit tight fit of external wall insulation.
- A flexible sealant should be applied to the junction between the plaster/ plasterboard, sill board and window frame member
- Sealant should be added to the front and back of the sill board
- Ensure that the damp proof course is correctly positioned.
- Reliance on effective weather proofing around openings should not be placed on mastic sealants alone and agreement for solutions should be sought from both building control and warranty provider prior to installation.