

LABC Registered Construction Details

Masonry

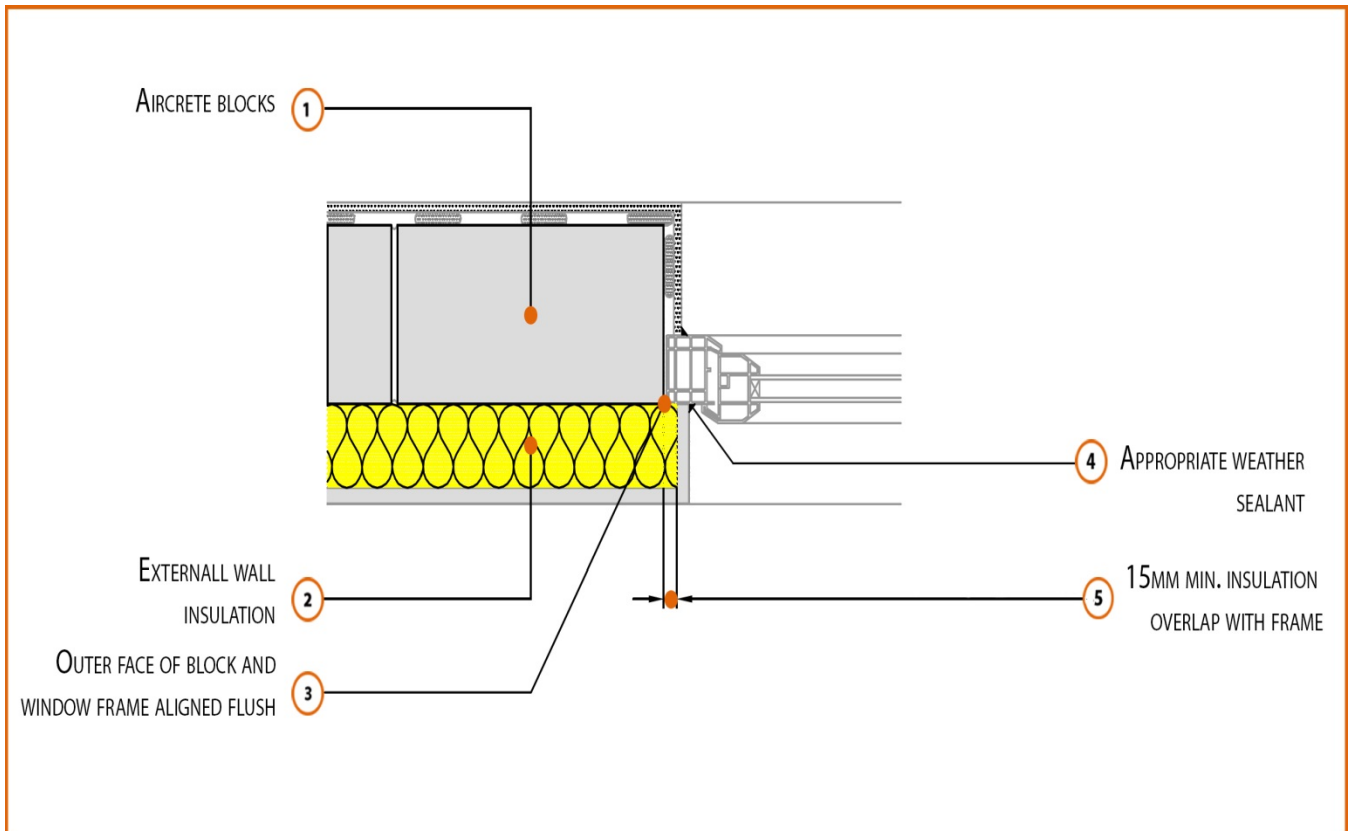

Registration Number: E4SMEW4



Build Up

Solid External Masonry Wall

215mm Aircrete Solid Wall ($\lambda \leq 0.15$ W/mK)

Render & Insulation ($\lambda = 0.038$ W/mK)



Calculated ψ -values

Cavity Insulation	Inner leaf blockwork
	Aircrete Block $\lambda \leq 0.15$ W/mK
	ψ -value W/mK
75mm $\lambda=0.038$	0.014
100mm $\lambda=0.038$	0.016
150mm $\lambda=0.038$	0.021

Points to Watch

- A flexible sealant should be used between all interfaces of the internal air barrier and the window / door frame members.
- Window and door openers should be carefully dimensioned to accommodate projection of insulation over frame.
- Ensure block face is kept clean of mortar snots and other debris during construction to permit tight fit of external wall insulation.
- Ensure that the damp proof course is correctly positioned.
- This detail cannot be used if a checked reveal is proposed.
- Reliance on effective weather proofing around openings should not be placed on mastic sealants alone and agreement for solutions should be sought from both building control and warranty provider prior to installation.