

# LABC Registered Construction Details

## Masonry

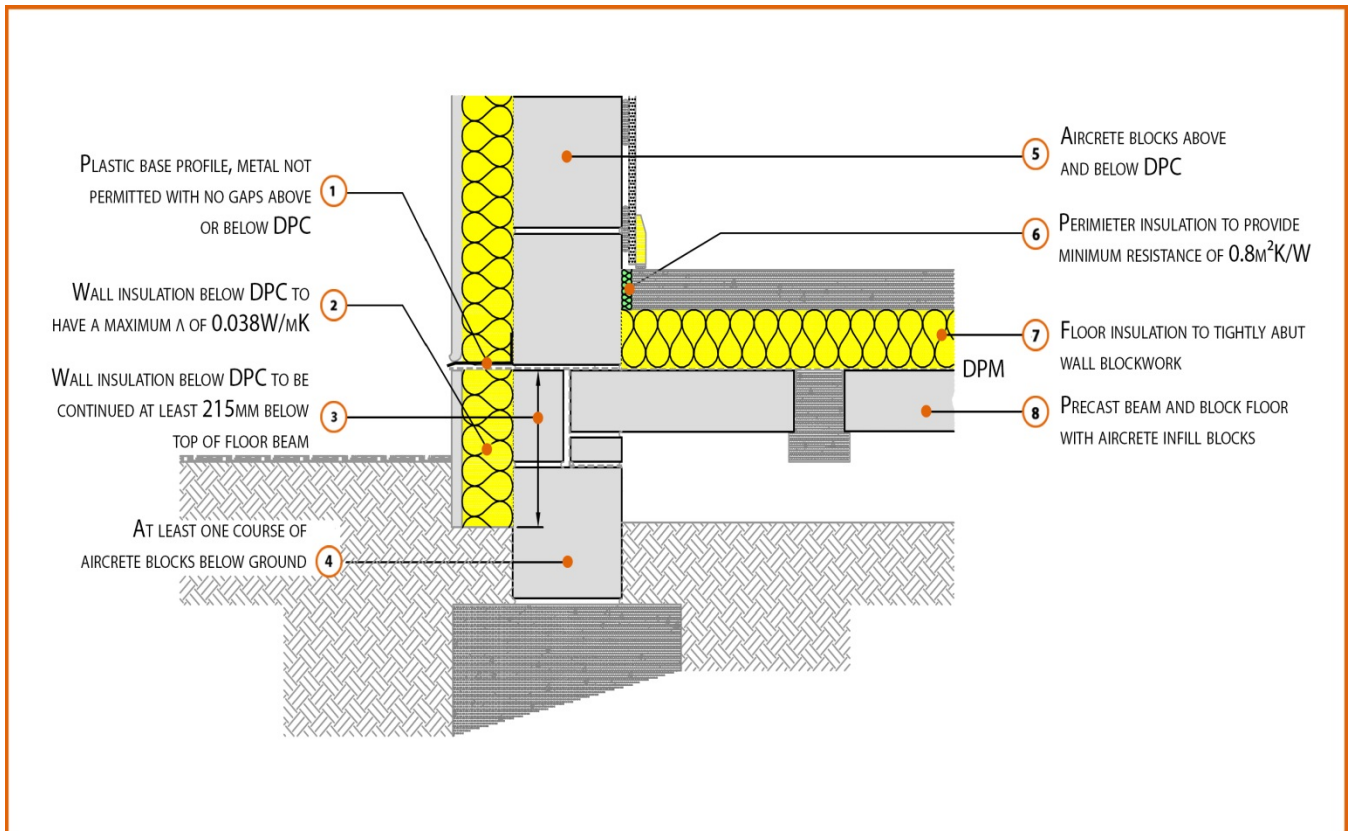

Registration Number: E5SMEW10



### Build Up

Solid External Masonry Wall

215mm Aircrete Solid Wall ( $\lambda \leq 0.15$  W/mK)

Render & Insulation ( $\lambda = 0.038$  W/mK)

150mm Beam and Aircrete Block Infill

150mm Insulation Above Slab (0.022W/mK)

75mm Screed



## Calculated $\psi$ -values

Cavity Insulation	Inner leaf blockwork
	Aircrete Block $\lambda \leq 0.15$ W/mK
	$\psi$ -value W/mK
75mm $\lambda=0.038$	0.062
100mm $\lambda=0.038$	0.063
150mm $\lambda=0.038$	0.065

## Points to Watch

- Ensure block face is kept clean of mortar snots and other debris during construction to permit tight fit of external wall insulation.
- Damp proof membrane / air barrier should be lapped to damp proof course and plaster stop bead.
- Any service penetrations through the damp proof membrane / air barrier should be suitably sealed.
- Sub floor ventilation to be in accordance with manufacturers recommendations. A cavity barrier type sleeve should be used through the cavity.
- The wall insulation installed must be considered fit for purpose below the wall dpc in relation to water absorption.
- Seal between the wall air barrier and the floor above and below the connection with a flexible sealant.
- Render above dpc should finish with a defined plastic bell-cast render-stop. This will avoid the dpc being rendered over and bridged.
- Floor insulation must tightly abut the blockwork wall.